

# XC9206/XC9207/XC9208 Series

ETR0503\_002a

PWM, PWM / PFM Switchable Step-Down  
DC / DC Converters With Driver Transistor Built-In

☆GO-Compatible

## ■ GENERAL DESCRIPTION

The XC9206/XC9207/XC9208 series is a group of DC/DC converters with a built-in 0.4Ω P-channel driver transistor, offered in a SOT-25 package. The ICs are designed to provide high efficiencies and a stable power supply with an output current of 500mA using only a coil, a diode and two ceramic capacitors connected externally. Minimum operating voltage of the XC9206/9207 is 1.8V and 2.0V for XC9208. Output voltage is internally programmable in a range from 0.9V to 4.0V in 100mV increments (accuracy: ±2.0%). Oscillation frequency is selectable from 300kHz, 600kHz and 1.2MHz so that the frequency best suited to your particular application can be selected. Each series features different operation modes: PWM control (XC9206 series), automatic PWM/PFM switching control (XC9207 series) and manual PWM/PFM switching control (XC9208 series). The series gives fast transient response, low ripple and high efficiency over the full range of load (from light load to high output current conditions). The soft start and current control functions are internally optimized. During stand-by, all circuits are shutdown to reduce current consumption to as low as 1.0μA or less. With the built-in U.V.L.O. (Under Voltage Lock Out) function, the internal P-channel driver transistor is forced OFF when input voltage becomes 1.4V or lower.

## ■ APPLICATIONS

- Mobile phones  
(PDC, GSM, CDMA, IMT2000 etc.)
- PDAs, Portable communication modems
- Portable games
- Cameras, digital cameras
- Cordless phones
- Note book computers

## ■ FEATURES

- P-ch driver Tr. Built-in** : ON resistance 0.4Ω
- Output Voltage Range** : 0.9V ~ 4.0V  
(100mV increments)  
Fixed output voltage accuracy ±2%
- Oscillation Frequency** : 300kHz, 600kHz, 1.2MHz  
Fixed oscillation frequency  
Accuracy ±15%
- Stand-by function** : I<sub>stb</sub> = 1μA (MAX.)
- Current Limiter built-in** : 600mA
- Input Voltage Range** : 1.8V ~ 6.0V(XC9206/XC9207)  
2.0V ~ 6.0V (XC9208)
- Output Current** : 500mA
- Maximum Duty Ratio** : 100%
- PWM/PFM Switching Control (XC9207 / XC9208)**
- Ceramic Capacitor Compatible**
- Soft start circuit built-in**
- Small Package** : SOT-25

## ■ TYPICAL APPLICATION CIRCUIT

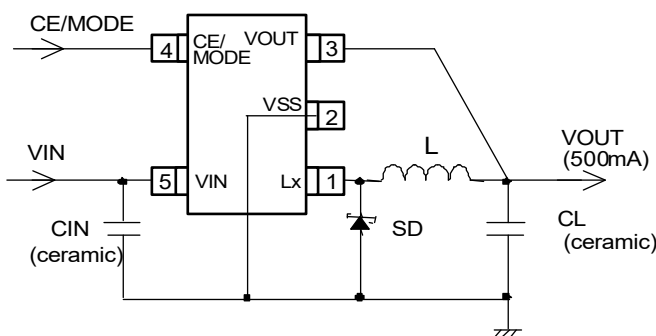

- L : 4.7μF (CDRH 3D16,SUMIDA)
- SD : CRS02 (SCHOTTKY DIODE,TOSHIBA)
- CL : 10μF (ceramic)
- CIN : 4.7μF (ceramic)

## ■ TYPICAL PERFORMANCE CHARACTERISTICS

- Efficiency vs. Output Current

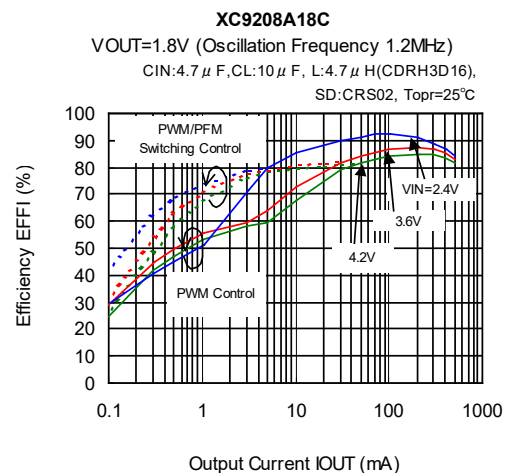

## ■ PIN CONFIGURATION

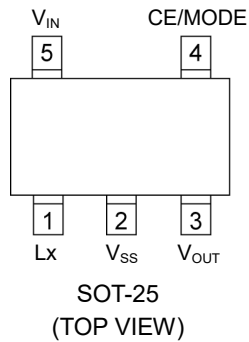

## ■ PIN ASSIGNMENT

PIN NUMBER	PIN NAME	FUNCTION
1	LX	Switching Output
2	VSS	Ground
3	VOUT	Output Voltage Sense
4	CE/MODE	Chip Enable/Mode Switch
5	VIN	Power Input

## ■ PRODUCT CLASSIFICATION

### ● Ordering Information

XC9206①②③④⑤⑥: PWM Control

XC9207①②③④⑤⑥: PWM / PFM Automatic Switching Control

XC9208①②③④⑤⑥: PWM Control, PWM / PFM Automatic Switching Control Manually Selectable

DESIGNATOR	DESCRIPTION	SYMBOL	DESCRIPTION
①	Type of DC/DC Converter	A	: 600mA current limiter, Transistor built-in, output voltage internally set (V <sub>OUT</sub> product), soft start internally set.
②③	Output Voltage	09~40	: 100mV increments e.g. V <sub>OUT</sub> =1.5V → ②=1, ③=5
		09~40 & L	: 1.85V V <sub>OUT</sub> → ②=1, ③=L 2.85V V <sub>OUT</sub> → ②=2, ③=L
④	Oscillation Frequency	3	: 300kHz
		6	: 600kHz
		C	: 1.2MHz
⑤	Package	M	: SOT-25 (SOT-23-5)
⑥	Device Orientation	R	: Embossed tape, standard feed
		L	: Embossed tape, reverse feed

\* Output voltage 0.9V ~ 4.0V (100mV increments), 1.85V and 2.85V are standard products.  
Output voltage other than these are available as semi-custom products.

## ■ BLOCK DIAGRAM

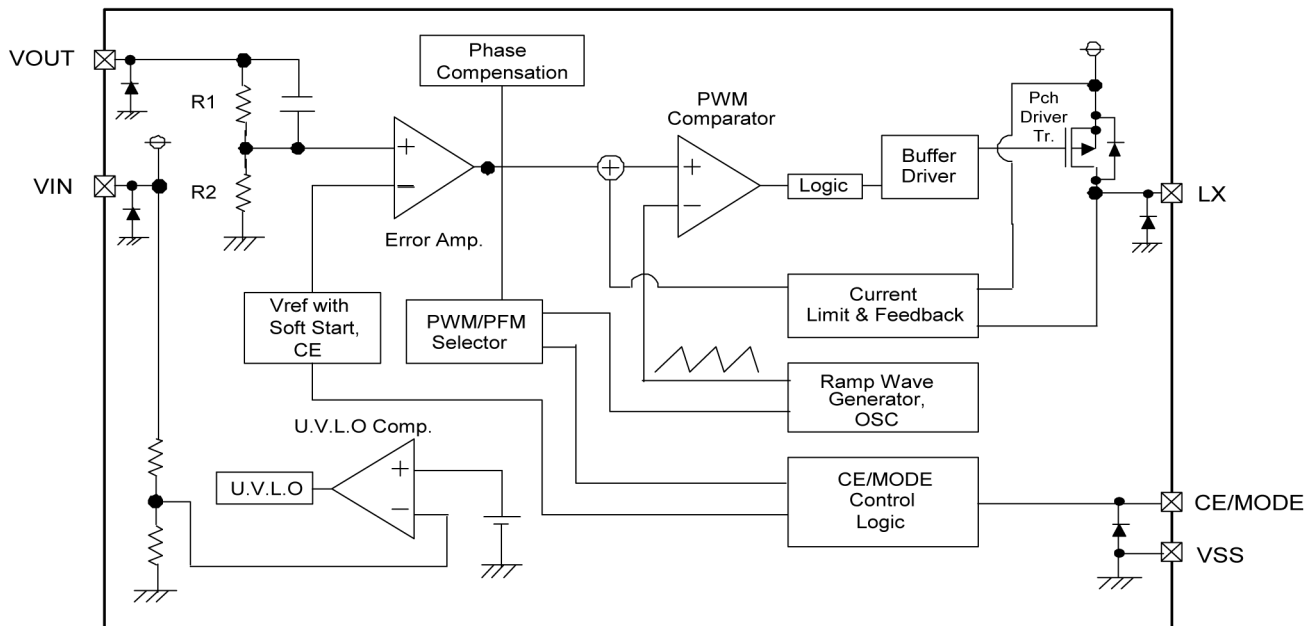

Note: The signal from CE/MODE Control Logic to PWM/PFM Selector is being fixed to "L" level inside, and XC9206 series chooses PWM control.

The signal from CE/MODE Control Logic to PWM/PFM Selector is being fixed to "H" level inside, and XC9207 series chooses only PWM/PFM automatic switching control.

## ■ ABSOLUTE MAXIMUM RATINGS

Ta=25°C

PARAMETER	SYMBOL	RATINGS	UNITS
VIN Pin Voltage	VIN	- 0.3 ~ + 6.5	V
Vss Pin Voltage	Vss	- 0.3 ~ + 6.5	V
Lx Pin Voltage	VLx	- 0.3 ~ VIN + 0.3	V
VOUT Pin Voltage	VOUT	- 0.3 ~ + 6.5	V
CE / MODE Pin Voltage	VCE	- 0.3 ~ VIN + 0.3	V
Lx Pin Current	ILx	± 1000	mA
Power Dissipation	Pd	250	mW
Operating Temperature Range	Topr	- 40 ~ + 85	°C
Storage Temperature Range	Tstg	- 55 ~ + 125	°C

## ELECTRICAL CHARACTERISTICS

XC9206A18CMR, XC9207A18CMR, XC9208A18CMR

V<sub>OUT</sub>=1.8V, FOSC=1.2MHz, T<sub>a</sub>=25°C

PARAMETER	SYMBOL	CONDITIONS	MIN.	TYP.	MAX.	UNIT	CIRCUIT
Output Voltage	V <sub>OUT</sub>	When connected to ext. components CE=V <sub>IN</sub> , I <sub>OUT</sub> =30mA	1.764	1.800	1.836	V	①
Operating Voltage Range	V <sub>IN</sub>	(XC9206, 9207)	1.8	-	6.0	V	①
		(XC9208)	2.0	-	6.0		
Maximum Output Current	I <sub>OUTMAX</sub>	When connected to ext. components	500	-	-	mA	①
U.V.L.O. Voltage	V <sub>UVLO</sub>	CE=V <sub>IN</sub> , V <sub>OUT</sub> =0V, Voltage which Lx pin voltage holding "L" level <sup>(*1)</sup>	1.00	1.40	1.78	V	②
Supply Current 1	I <sub>DD1</sub>	CE=V <sub>IN</sub> , V <sub>OUT</sub> =fixed voltage x 0.9V	-	255	413	μA	③
Supply Current 2	I <sub>DD2</sub>	CE=V <sub>IN</sub> , V <sub>OUT</sub> =fixed voltage x 1.1V	-	98	158	μA	③
Stand-by Current	I <sub>STB</sub>	CE=V <sub>SS</sub> , V <sub>OUT</sub> =fixed voltage x 1.1V	-	0	1	μA	③
Oscillation Frequency	FOSC	When connected to ext. components CE=V <sub>IN</sub> , I <sub>OUT</sub> =30mA	1.020	1.200	1.380	MHz	①
PFM Pulse Width Rate	PFMDTY	When connected to ext. components (XC9207, XC9208 only), CE=V <sub>IN</sub> , I <sub>OUT</sub> =1mA	24	30	36	%	①
Maximum Duty Cycle	MAXDTY	CE=V <sub>IN</sub> , V <sub>OUT</sub> =0V	100	-	-	%	②
Minimum Duty Cycle	MINDTY	CE=V <sub>OUT</sub> =V <sub>IN</sub>	-	-	0	%	②
Efficiency <sup>(*2)</sup>	EFFI	When connected to ext. components, CE=V <sub>IN</sub> , I <sub>OUT</sub> =100mA	-	86	-	%	①
Lx SW ON Resistance	R <sub>Lx</sub>	CE=V <sub>IN</sub> , V <sub>OUT</sub> =0V, I <sub>Lx</sub> =400mA <sup>(*3)</sup>	-	0.4	0.9	Ω	④
Current Limit	I <sub>LIM</sub>	V <sub>IN</sub> =CE=5.0V, V <sub>OUT</sub> =0V	-	600	-	mA	④
CE "H" Voltage	V <sub>CEH</sub>	(XC9206, 9207) V <sub>OUT</sub> =0V, When CE voltage is applied Lx determine "H"	1.2	-	V <sub>IN</sub>	V	⑤
		(XC9208)	0.9	-	V <sub>IN</sub>		
CE "L" Voltage	V <sub>CEL</sub>	V <sub>OUT</sub> =0V, When CE voltage is applied Lx determine "L"	V <sub>SS</sub>	-	0.3	V	⑤
PWM "H" Voltage	V <sub>PWMH</sub>	When connected to ext. components (XC9208 only), I <sub>OUT</sub> =1mA <sup>(*4)</sup>	V <sub>IN</sub> -0.3	-	-	V	①
PWM "L" Voltage	V <sub>PWML</sub>	When connected to ext. components (XC9208 only), I <sub>OUT</sub> =1mA <sup>(*4)</sup>	-	-	V <sub>IN</sub> -1.0	V	①
CE "H" Current	I <sub>CEH</sub>	CE=V <sub>IN</sub> =5.5V, V <sub>OUT</sub> =0V	-0.1	-	0.1	μA	⑤
CE "L" Current	I <sub>CEL</sub>	CE=0V, V <sub>IN</sub> =5.5V, V <sub>OUT</sub> =0V	-0.1	-	0.1	μA	⑤
Soft-Start Time	T <sub>SS</sub>	When connected to ext. components CE=0V → V <sub>IN</sub> , I <sub>OUT</sub> =1mA	0.8	-	6.0	ms	①
Latch Time	T <sub>lat</sub>	When connected to ext. components V <sub>IN</sub> =CE=5.0V, short V <sub>OUT</sub> by 1Ω resistance <sup>(*5)</sup>	-	-	12.0	ms	⑥

Test condition: Unless otherwise stated, V<sub>IN</sub> = 3.6V

NOTE:

\*1: Including hysteresis operating voltage range.

\*2: EFFI = [ (output voltage x output current) / (input voltage x input current) ] x 100

\*3: On resistance = V<sub>Lx</sub> (measurement voltage) / 0.4

\*4: The CE/MODE pin of the XC9208A series works also as an external PWM control and PWM/PFM control switching pin. When the IC is in the operation, control is switched to the PWM mode when the CE/MODE pin voltage is equal to or greater than V<sub>IN</sub> minus 0.3 V, and to the automatic PWM/PFM switching mode when the CE/MODE pin voltage is equal to or lower than V<sub>IN</sub> minus 1.0 V and equal to or greater than V<sub>CEH</sub>.

\*5: Time until it short-circuits V<sub>OUT</sub> with GND through 1Ω of resistance from a state of operation and is set to V<sub>OUT</sub>=0V from current limit pulse generating.

## ■ ELECTRICAL CHARACTERISTICS (Continued)

XC9206A25CMR, XC9207A25CMR, XC9208A25CMR

V<sub>OUT</sub>=2.5V, FOSC=1.2MHz, Ta=25°C

PARAMETER	SYMBOL	CONDITIONS	MIN.	TYP.	MAX.	UNIT	CIRCUIT
Output Voltage	V <sub>OUT</sub>	When connected to ext. components CE=V <sub>IN</sub> , I <sub>OUT</sub> =30mA	2.450	2.500	2.550	V	①
Operating Voltage Range	V <sub>IN</sub>	(XC9206, 9207)	1.8	-	6.0	V	①
		(XC9208)	2.0	-	6.0		
Maximum Output Current	I <sub>OUTMAX</sub>	When connected to ext. components	500	-	-	mA	①
U.V.L.O. Voltage	V <sub>UVLO</sub>	CE=V <sub>IN</sub> , V <sub>OUT</sub> =0V, Voltage which Lx pin voltage holding "L" level <sup>(*)1</sup>	1.00	1.40	1.78	V	②
Supply Current 1	I <sub>DD1</sub>	CE=V <sub>IN</sub> , V <sub>OUT</sub> =fixed voltage x 0.9V	-	255	413	μA	③
Supply Current 2	I <sub>DD2</sub>	CE=V <sub>IN</sub> , V <sub>OUT</sub> =fixed voltage x 1.1V	-	98	158	μA	③
Stand-by Current	I <sub>STB</sub>	CE=V <sub>SS</sub> , V <sub>OUT</sub> =fixed voltage x 1.1V	-	0	1	μA	③
Oscillation Frequency	FOSC	When connected to ext. components CE=V <sub>IN</sub> , I <sub>OUT</sub> =30mA	1.020	1.200	1.380	MHz	①
PFM Pulse Width Rate	PFMDTY	When connected to ext. components (XC9207, XC9208 only), CE=V <sub>IN</sub> , I <sub>OUT</sub> =1mA	24	30	36	%	①
Maximum Duty Cycle	MAXDTY	CE=V <sub>IN</sub> , V <sub>OUT</sub> =0V	100	-	-	%	②
Minimum Duty Cycle	MINDTY	CE=V <sub>OUT</sub> =V <sub>IN</sub>	-	-	0	%	②
Efficiency <sup>(*)2</sup>	EFFI	When connected to ext. components, CE=V <sub>IN</sub> , I <sub>OUT</sub> =100mA	-	91	-	%	①
Lx SW ON Resistance	R <sub>Lx</sub>	CE=V <sub>IN</sub> , V <sub>OUT</sub> =0V, I <sub>Lx</sub> =400mA <sup>(*)3</sup>	-	0.4	0.9	Ω	④
Current Limit	I <sub>LIM</sub>	V <sub>IN</sub> =CE=5.0V, V <sub>OUT</sub> =0V	-	600	-	mA	④
CE "H" Voltage	V <sub>CEH</sub>	(XC9206, 9207)	1.2	-	V <sub>IN</sub>	V	⑤
		(XC9208)	0.9	-	V <sub>IN</sub>		
CE "L" Voltage	V <sub>CEL</sub>	V <sub>OUT</sub> =0V, When CE voltage is applied Lx determine "L"	V <sub>SS</sub>	-	0.3	V	⑤
PWM "H" Voltage	V <sub>PWMH</sub>	When connected to ext. components (XC9208 only), I <sub>OUT</sub> =1mA <sup>(*)4</sup>	V <sub>IN</sub> -0.3	-	-	V	①
PWM "L" Voltage	V <sub>PWML</sub>	When connected to ext. components (XC9208 only), I <sub>OUT</sub> =1mA <sup>(*)4</sup>	-	-	V <sub>IN</sub> -1.0	V	①
CE "H" Current	I <sub>CEH</sub>	CE=V <sub>IN</sub> =5.5V, V <sub>OUT</sub> =0V	-0.1	-	0.1	μA	⑤
CE "L" Current	I <sub>CEL</sub>	CE=0V, V <sub>IN</sub> =5.5V, V <sub>OUT</sub> =0V	-0.1	-	0.1	μA	⑤
Soft-Start Time	T <sub>SS</sub>	When connected to ext. components CE=0V → V <sub>IN</sub> , I <sub>OUT</sub> =1mA	0.8	-	6.0	ms	①
Latch Time	T <sub>lat</sub>	When connected to ext. components V <sub>IN</sub> =CE=5.0V, short V <sub>OUT</sub> by 1Ω resistance <sup>(*)5</sup>	-	-	12.0	ms	⑥

Test condition : Unless otherwise stated, V<sub>IN</sub> = 3.6V

NOTE:

\*1 : Including hysteresis operating voltage range.

\*2 : EFFI = [ (output voltage x output current) / (input voltage x input current) ] x 100

\*3 : On resistance = V<sub>Lx</sub> (measurement voltage) / 0.4

\*4 : The CE/MODE pin of the XC9208A series works also as an external PWM control and PWM/PFM control switching pin. When the IC is in the operation, control is switched to the PWM mode when the CE/MODE pin voltage is equal to or greater than V<sub>IN</sub> minus 0.3 V, and to the automatic PWM/PFM switching mode when the CE/MODE pin voltage is equal to or lower than V<sub>IN</sub> minus 1.0 V and equal to or greater than V<sub>CEH</sub>.

\*5 : Time until it short-circuits V<sub>OUT</sub> with GND through 1Ω of resistance from a state of operation and is set to V<sub>OUT</sub>=0V from current limit pulse generating.

## ■ ELECTRICAL CHARACTERISTICS (Continued)

XC9206A33CMR, XC9207A33CMR, XC9208A33CMR

V<sub>OUT</sub>=3.3V, FOSC=1.2MHz, T<sub>a</sub>=25°C

PARAMETER	SYMBOL	CONDITIONS	MIN.	TYP.	MAX.	UNIT	CIRCUIT
Output Voltage	V <sub>OUT</sub>	When connected to ext. components CE=V <sub>IN</sub> , I <sub>OUT</sub> =30mA	3.234	3.300	3.366	V	①
Operating Voltage Range	V <sub>IN</sub>	(XC9206, 9207)	1.8	-	6.0	V	①
		(XC9208)	2.0	-	6.0		
Maximum Output Current	I <sub>OUTMAX</sub>	When connected to ext. components	500	-	-	mA	①
U.V.L.O. Voltage	V <sub>UVLO</sub>	CE=V <sub>IN</sub> , V <sub>OUT</sub> =0V, Voltage which Lx pin voltage holding "L" level <sup>(*)1</sup>	1.00	1.40	1.78	V	②
Supply Current 1	I <sub>DD1</sub>	CE=V <sub>IN</sub> , V <sub>OUT</sub> =fixed voltage x 0.9V	-	370	585	μA	③
Supply Current 2	I <sub>DD2</sub>	CE=V <sub>IN</sub> , V <sub>OUT</sub> =fixed voltage x 1.1V	-	120	180	μA	③
Stand-by Current	I <sub>stb</sub>	CE=V <sub>SS</sub> , V <sub>OUT</sub> =fixed voltage x 1.1V	-	0	1	μA	③
Oscillation Frequency	FOSC	When connected to ext. components CE=V <sub>IN</sub> , I <sub>OUT</sub> =30mA	1.020	1.200	1.380	MHz	①
PFM Pulse Width Rate	PFMDTY	When connected to ext. components (XC9207, XC9208 only), CE=V <sub>IN</sub> , I <sub>OUT</sub> =1mA	26	32	38	%	①
Maximum Duty Cycle	MAXDTY	CE=V <sub>IN</sub> , V <sub>OUT</sub> =0V	100	-	-	%	②
Minimum Duty Cycle	MINDTY	CE=V <sub>OUT</sub> =V <sub>IN</sub>	-	-	0	%	②
Efficiency <sup>(*)2</sup>	EFFI	When connected to ext. components, CE=V <sub>IN</sub> , I <sub>OUT</sub> =100mA	-	92	-	%	①
Lx SW ON Resistance	R <sub>Lx</sub>	CE=V <sub>IN</sub> , V <sub>OUT</sub> =0V, I <sub>Lx</sub> =400mA <sup>(*)3</sup>	-	0.4	0.9	Ω	④
Current Limit	I <sub>LIM</sub>	V <sub>IN</sub> =CE=5.0V, V <sub>OUT</sub> =0V	-	600	-	mA	④
CE "H" Voltage	V <sub>CEH</sub>	(XC9206, 9207)	1.2	-	V <sub>IN</sub>	V	⑤
		(XC9208)	0.9	-	V <sub>IN</sub>		
CE "L" Voltage	V <sub>CEL</sub>	V <sub>OUT</sub> =0V, When CE voltage is applied Lx determine "L"	V <sub>SS</sub>	-	0.3	V	⑤
PWM "H" Voltage	V <sub>PWMH</sub>	When connected to ext. components (XC9208 only), I <sub>OUT</sub> =1mA <sup>(*)4</sup>	V <sub>IN</sub> -0.3	-	-	V	①
PWM "L" Voltage	V <sub>PWML</sub>	When connected to ext. components (XC9208 only), I <sub>OUT</sub> =1mA <sup>(*)4</sup>	-	-	V <sub>IN</sub> -1.0	V	①
CE "H" Current	I <sub>CEH</sub>	CE=V <sub>IN</sub> =5.5V, V <sub>OUT</sub> =0V	-0.1	-	0.1	μA	⑤
CE "L" Current	I <sub>CEL</sub>	CE=0V, V <sub>IN</sub> =5.5V, V <sub>OUT</sub> =0V	-0.1	-	0.1	μA	⑤
Soft Start Time	T <sub>SS</sub>	When connected to ext. components CE=0V → V <sub>IN</sub> , I <sub>OUT</sub> =1mA	0.8	-	6.0	ms	①
Latch Time	T <sub>lat</sub>	When connected to ext. components V <sub>IN</sub> =CE=5.0V, short V <sub>OUT</sub> by 1Ω resistance <sup>(*)5</sup>	-	-	12.0	ms	⑥

Test condition: Unless otherwise stated, V<sub>IN</sub> = 5.0V

NOTE:

\*1: Including hysteresis operating voltage range.

\*2: EFFI = [ (output voltage x output current) / (input voltage x input current) ] x 100

\*3: On resistance = V<sub>Lx</sub> (measurement voltage) / 0.4

\*4: The CE/MODE pin of the XC9208A series works also as an external PWM control and PWM/PFM control switching pin. When the IC is in the operation, control is switched to the PWM mode when the CE/MODE pin voltage is equal to or greater than V<sub>IN</sub> minus 0.3 V, and to the automatic PWM/PFM switching mode when the CE/MODE pin voltage is equal to or lower than V<sub>IN</sub> minus 1.0 V and equal to or greater than V<sub>CEH</sub>.

\*5: Time until it short-circuits V<sub>OUT</sub> with GND through 1Ω of resistance from a state of operation and is set to V<sub>OUT</sub>=0V from current limit pulse generating.

## TYPICAL APPLICATION CIRCUIT

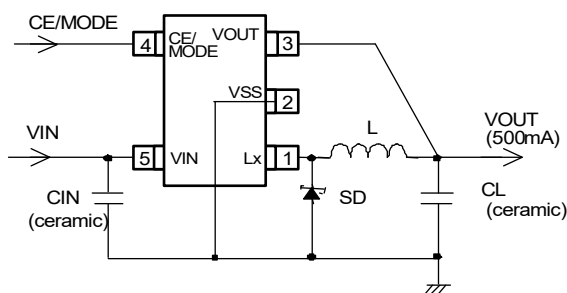

\* XC9206/9207/9208 series wire connection

- |   |   |
|---|---|
| <p>● FOSC=1.2MHz<br/>                 L : 4.7 <math>\mu</math> H (CDRH3D16, SUMIDA)<br/>                 SD : CRS02 (TOSHIBA)<br/>                 CIN : 4.7 <math>\mu</math> F (Ceramic)<br/>                 CL : 10 <math>\mu</math> F (Ceramic)</p> | <p>● FOSC=600kHz<br/>                 L : 10 <math>\mu</math> H (CDRH4D18C, SUMIDA)<br/>                 SD : CRS02 (TOSHIBA)<br/>                 CIN : 4.7 <math>\mu</math> F (Ceramic)<br/>                 CL : 10 <math>\mu</math> F (Ceramic)</p> |
| <p>● FOSC=300kHz<br/>                 L : 22 <math>\mu</math> H (CDRH4D18, SUMIDA)<br/>                 SD : CRS02 (TOSHIBA)<br/>                 CIN : 4.7 <math>\mu</math> F (Ceramic)<br/>                 CL : 10 <math>\mu</math> F (Ceramic)</p>  | <p>*SD : Schottky diode</p>   |

## OPERATIONAL EXPLANATION

Each unit of the XC9206/9207/9208 series consists of a reference voltage source, ramp wave circuit, error amplifier, PWM comparator, phase compensation circuit, output voltage adjustment resistors, driver transistor, current limiter circuit, U.V.L.O. circuit and others. The series ICs compare, using the error amplifier, the voltage of the internal voltage reference source with the feedback voltage from the VOUT pin through resistors R1 and R2. Phase compensation is performed on the resulting error amplifier output, to input a signal to the PWM comparator to determine the turn-on time during PWM operation. The PWM comparator compares, in terms of voltage level, the signal from the error amplifier with the ramp wave from the ramp wave circuit, and delivers the resulting output to the buffer driver circuit to cause the Lx pin to output a switching duty cycle. This process is continuously performed to ensure stable output voltage. The current feedback circuit monitors the P-channel MOS driver transistor current for each switching operation, and modulates the error amplifier output signal to provide multiple feedback signals. This enables a stable feedback loop even when a low ESR capacitor, such as a ceramic capacitor, is used, ensuring stable output voltage.

### < Reference Voltage Source >

The reference voltage source provides the reference voltage to ensure stable output voltage of the ICs.

### < Ramp Wave Circuit >

The ramp wave circuit determines switching frequency. The frequency is fixed internally and can be selected from 300kHz, 600 kHz and 1.2 MHz. Clock pulses generated in this circuit are used to produce ramp waveforms needed for PWM operation, and to synchronize all the internal circuits.

### < Error Amplifier >

The error amplifier is designed to monitor output voltage. The amplifier compares the reference voltage with the feedback voltage divided by the internal resistors (R1 and R2). When a voltage lower than the reference voltage is fed back, the output voltage of the error amplifier increases. The gain and frequency characteristics of the error amplifier output are fixed internally to deliver an optimized signal to the mixer.

### <Current Limit>

The current limiter circuit of the XC9206/9207/9208 series monitors the current flowing through the P-channel MOS driver transistor connected to the Lx pin, and features a combination of the constant-current type current limit mode and the operation suspension mode.

- ① When the driver current is greater than a specific level, the constant-current type current limit function operates to turn off the pulses from the Lx pin at any given timing.
- ② When the driver transistor is turned off, the limiter circuit is then released from the current limit detection state.
- ③ At the next pulse, the driver transistor is turned on. However, the transistor is immediately turned off in the case of an over current state.
- ④ When the over current state is eliminated, the IC resumes its normal operation.

The IC waits for the over current state to end by repeating the steps ① through ③. If an over current state continues for several msec and the above three steps are repeatedly performed, the IC performs the function of latching the OFF state of the driver transistor, and goes into operation suspension mode. Once the IC is in suspension mode, operations can be resumed by either turning the IC off via the CE /MODE pin, or by restoring power to the VIN pin. The suspension mode does not mean a complete shutdown, but a state in which pulse output is suspended; therefore, the internal circuitry remains in operation. The constant-current type current limit of the XC9206A/9207A/9208A series can be set at 600 mA.

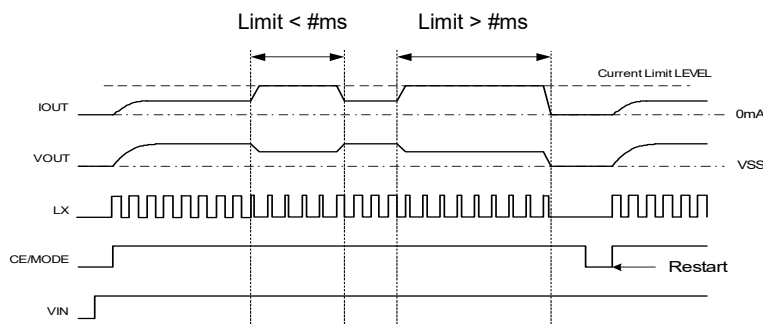

## OPERATIONAL EXPLANATION (Continued)

### < U.V.L.O. Circuit >

When the VIN pin voltage becomes 1.4 V or lower, the P-channel output driver transistor is forced OFF to prevent false pulse output caused by unstable operation of the internal circuitry. When the VIN pin voltage becomes 1.8 V or higher, switching operation takes place. By releasing the U.V.L.O. function, the IC performs the soft start function to initiate output startup operation. The soft start function operates even when the VIN pin voltage falls momentarily below the U.V.L.O. operating voltage. The U.V.L.O. circuit does not cause a complete shutdown of the IC, but causes pulse output to be suspended; therefore, the internal circuitry remains in operation.

### < Function of CE/MODE pin >

The XC9206/9207/9208 series will enter into shut down state by inputting a low level signal to the CE/MODE pin. During a shut down state, the current consumption of the IC becomes 0 μA (TYP.), with a state of high impedance at the Lx pin and VOUT pin. The IC starts its operation by inputting a high level signal to the CE/MODE pin. The input of the CE/MODE pin is a CMOS input and the sink current is 0 μA (TYP.).

### ●XC9206A / 07A series - Examples of how to use CE/MODE pin

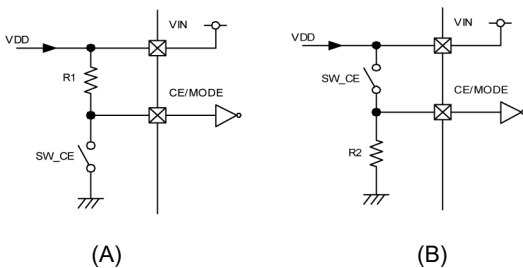

	SW_CE	STATUS
A	ON	Chip Disable
	OFF	PWM control (XC9206), PWM/PFM automatic switching control (XC9207)
B	ON	PWM control (XC9206), PWM/PFM automatic switching control (XC9207)
	OFF	Chip Disable

### ●XC9208A series - Examples of how to use CE/MODE pin

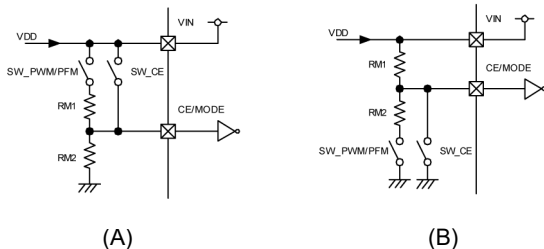

	SW_CE	SW_PWM/PFM	STATUS
A	ON	*	Synchronous PWM control
	OFF	ON	Non-synchronous PWM/PFM automatic switching control
	OFF	OFF	Chip Disable
B	ON	*	Chip Disable
	OFF	ON	Non-synchronous PWM/PFM automatic switching control
	OFF	OFF	Synchronous PWM control

Intermediate voltage can be generated by RM1 and RM2. Please set the value of each R1, R2, RM1, RM2 at around 100kΩ. For switches, CPU open-drain I/O port and transistor can be used.

### < PWM / PFM >

XC9207/9208 series features PWM/PFM automatic switching control.

With the automatic PWM/PFM switching control function, the series ICs are automatically switched from PWM control to PFM control mode under light load conditions. If during light load conditions the coil current becomes discontinuous and on-time rate falls lower than PFM duty, the PFM circuit operates to output a pulse with a fixed on-time rate from the Lx pin. During PFM operation with this fixed on-time rate, pulses are generated at different frequencies according to conditions of the moment. This causes a reduction in the number of switching operations per unit of time, resulting in efficiency improvement under light load conditions. However, since pulse output frequency is not constant, consideration should be given if a noise filter or the like is needed. Necessary conditions for switching to PFM operation depend on input voltage, load current, coil value and other factors.



## ■ NOTES ON USE

### ● Application Information

1. The XC9206/9207/9208 series are designed for use with an output ceramic capacitor. If, however, the potential difference between input and output is too large, a ceramic capacitor may fail to absorb the resulting high switching energy and oscillation could occur on the output. If the input-output potential difference is large, connect an electrolytic capacitor in parallel to compensate for insufficient capacitance.
2. Spike noise and ripple voltage arise in a switching regulator as with a DC/DC converter. These are greatly influenced by external component selection, such as the coil inductance, capacitance values, and board layout of external components. Once the design has been completed, verification with actual components should be done.
3. When the difference between  $V_{IN}$  and  $V_{OUT}$  is large and the load current is light, very narrow pulses will be outputted, and there is the possibility that some cycles may be skipped completely.

### ● Oscillation Wave Form (FOSC=1.2MHz)

- ①  $V_{IN} = 5.5V$ ,  $V_{OUT}=1.8V$ ,  $I_{OUT}=10mA$

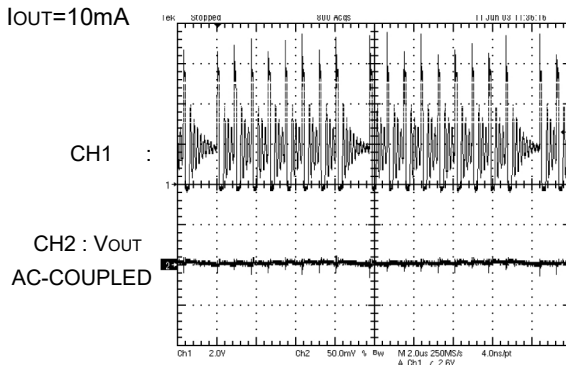

L : 4.7  $\mu$ H (CDRH3D16, SUMIDA)  
SD : CRS02 (TOSHIBA)  
C<sub>IN</sub> : 4.7  $\mu$ F (Ceramic)  
C<sub>L</sub> : 10  $\mu$ F (Ceramic)

4. When the difference between  $V_{IN}$  and  $V_{OUT}$  is small, and the load current is heavy, very wide pulses will be outputted and there is the possibility that some cycles may be skipped completely: in this case, the Lx pin may not go low at all.

### ● Oscillation Wave Form (FOSC=1.2MHz)

- ②  $V_{IN} = 2.0V$ ,  $V_{OUT}=1.8V$ ,  $I_{OUT}=60mA$

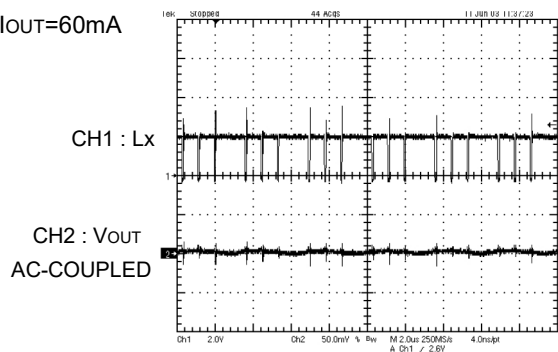

L : 4.7  $\mu$ H (CDRH3D16, SUMIDA)  
SD : CRS02 (TOSHIBA)  
C<sub>IN</sub> : 4.7  $\mu$ F (Ceramic)  
C<sub>L</sub> : 10  $\mu$ F (Ceramic)

5. With the IC, the peak current of the coil is controlled by the current limit circuit. Since the peak current increases when dropout voltage or load current is high, current limit starts operating, and this can lead to instability. When peak current becomes high, please adjust the coil inductance value and fully check the circuit operation. In addition, please calculate the peak current according to the following formula:

$$I_{pk} = (V_{IN} - V_{OUT}) \times \text{On Duty} / (2 \times L \times \text{FOSC}) + I_{OUT}$$

OnDut: OnDuty ratio of Pch Driver Transistor

L : Coil Inductance Value

FOSC : Oscillation Frequency

6. When the peak current which exceeds limit current flows within the specified time, the built-in P-ch driver transistor is turned off. During the time until it detects limit current and before the built-in transistor can be turned off, the current for limit current flows; therefore, care must be taken when selecting the rating for the coil or the schottky diode.
7. When  $V_{IN}$  is less than 2.4V, limit current may not be reached because voltage falls caused by ON resistance.

## NOTES ON USE (Continued)

### Application Information (Continued)

8. Care must be taken when laying out the PC Board, in order to prevent misoperation of the current limit mode. Depending on the state of the PC Board, latch time may become longer and latch operation may not work. In order to avoid the effect of noise, the board should be laid out so that capacitors are placed as close to the chip as possible.
9. Use of the IC at voltages below the recommended voltage range may lead to instability.
10. This IC should be used within the stated absolute maximum ratings in order to prevent damage to the device.
11. Depending on the input-output voltage differential, or load current, some pulses may be skipped, and the ripple voltage may increase. When the series' duty cycle is digitally signalized, the linear duty cycle and the digitally signalized duty cycle cannot carry out completely the same change, which means that the duty cycle does not change linearly. The output is stabilized by applying the phase compensation and adjusting the duty cycle, even when the duty cycle loses the linear change in the whole circuit. When the state where the output was stabilized is continued by applying phase compensation to duty cycle which lost linearity, ripple voltage does not increase more than it. The ripple voltage may increase to about several 10mV according to operating conditions. It is possible, by increasing the capacitance values, to reduce the ripple voltage. The operating conditions are greatly influenced by the dropout voltage, the load current, the delay-time, or the external components, such as the coil inductance, and the capacitance values. Verification with actual parts should be done.

### The Increase of Ripple Voltage (1.2MHz)

①  $V_{IN}=4.2V, V_{OUT}=1.8V, I_{OUT}=180mA$

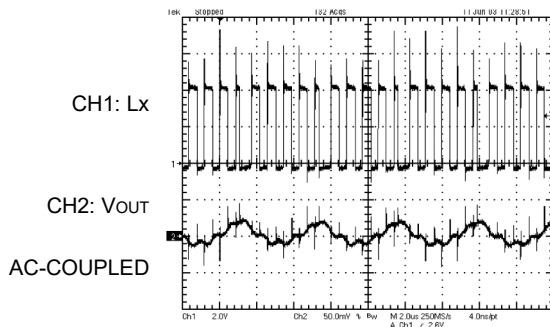

②  $V_{IN}=4.2V, V_{OUT}=1.8V, I_{OUT}=60mA$

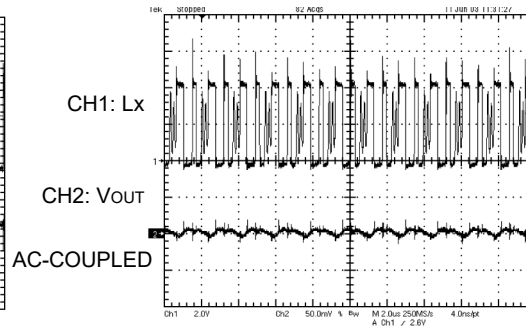

③  $V_{IN}=3.6V, V_{OUT}=1.8V, I_{OUT}=30mA$

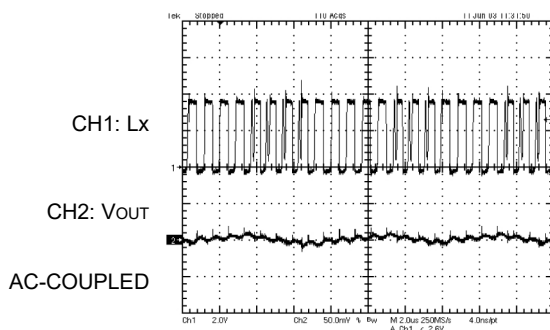

L :  $4.7 \mu H$  (CDRH3D16,  
SUMIDA)  
 SD : CRS02 (TOSHIBA)  
 C<sub>IN</sub> :  $4.7 \mu F$  (Ceramic)  
 C<sub>L</sub> :  $10 \mu F$  (Ceramic)

## ■ NOTES ON USE (Continued)

### ● Instructions on Pattern Layout

1. In order to stabilize  $V_{DD}$ 's voltage level, we recommend that a by-pass capacitor ( $C_{IN}$ ) be connected as close as possible to the  $V_{IN}$  &  $V_{SS}$  pins.
2. Please mount each external component as close to the IC as possible, and connect it to GND with the shortest possible PCB traces.
3. Wire external components as close to the IC as possible and use thick, short connecting traces to reduce the circuit impedance.
4. Make sure that the PCB GND traces are as thick as possible, as variations in ground potential caused by high ground currents at the time of switching may result in instability.
5. Please connect SD anode directly to the by-pass capacitor  $C_{IN}$  (-) in order to minimize SD noise affect on to the  $V_{SS}$  pin of the IC. Also, take distance between the  $V_{SS}$  pin and the SD anode for having large impedance as possible. We recommend that a ferrite bead mount pattern be arranged for the case that the SD noise can not be reduced by using the pattern layout as shown below.
6. Please do not make the traces under the IC to carry switching main current. It may cause a malfunction of the IC.

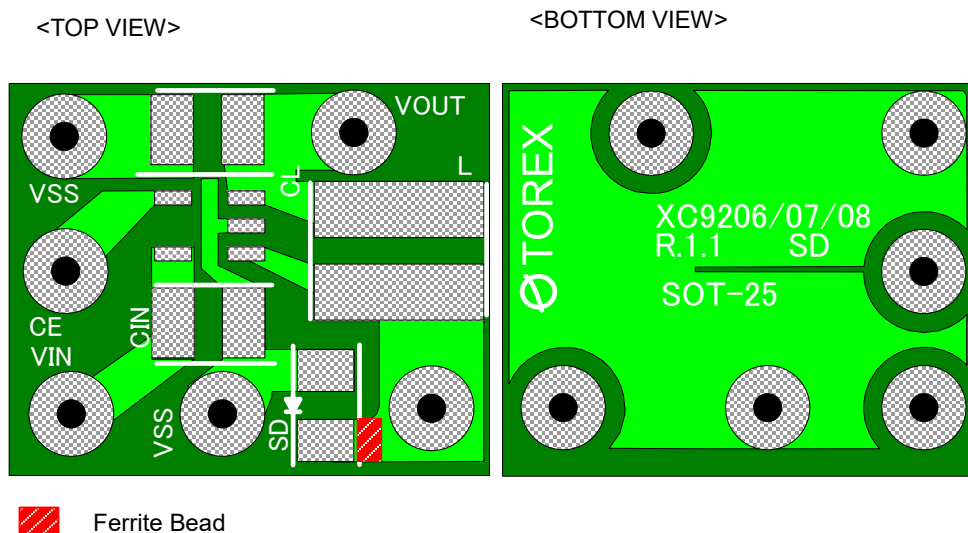
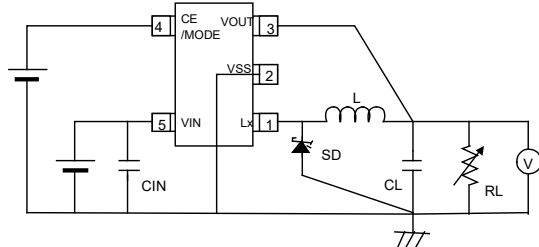

Figure XC9206/07/08Series Pattern Layout

## TEST CIRCUITS

Circuit ①



Circuit ②

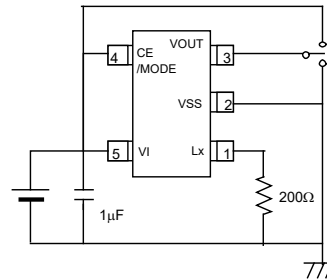

Circuit ③

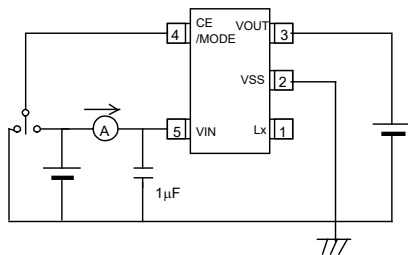

Circuit ④

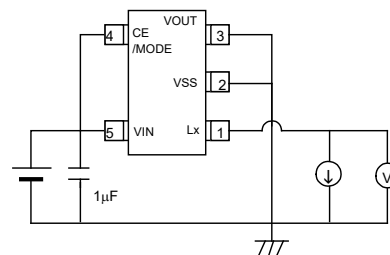

Circuit ⑤

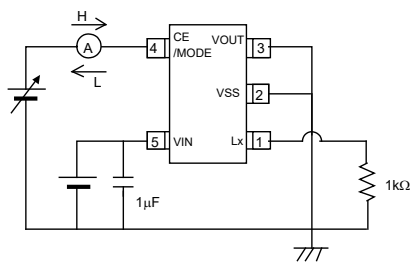

Circuit ⑥

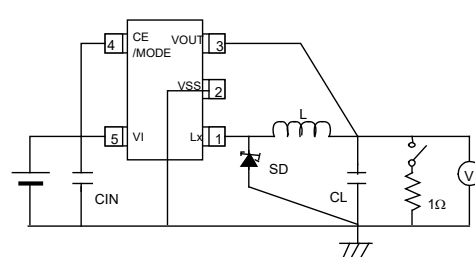

	1.2MHz	600kHz	300kHz
CIN	4.7 $\mu$ F (ceramic)	4.7 $\mu$ F (ceramic)	4.7 $\mu$ F (ceramic)
CL	10 $\mu$ F (ceramic)	10 $\mu$ F (ceramic)	10 $\mu$ F (ceramic)
L	4.7 $\mu$ H	10 $\mu$ H	22 $\mu$ H
SD	Schottky Diode	Schottky Diode	Schottky Diode

## TYPICAL PERFORMANCE CHARACTERISTICS

### (1) Output Voltage vs. Output Current

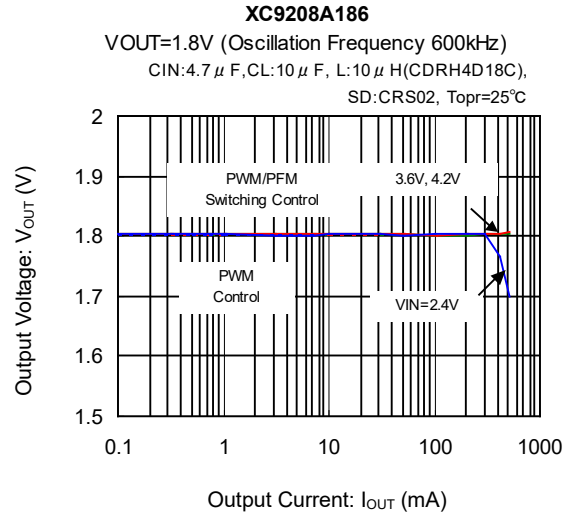
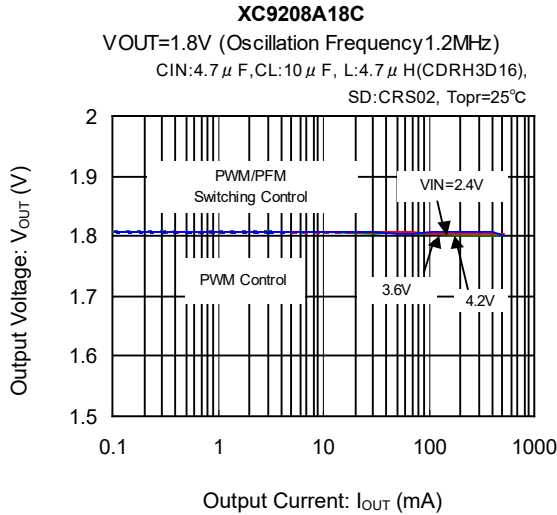

### (2) Efficiency vs. Output Current

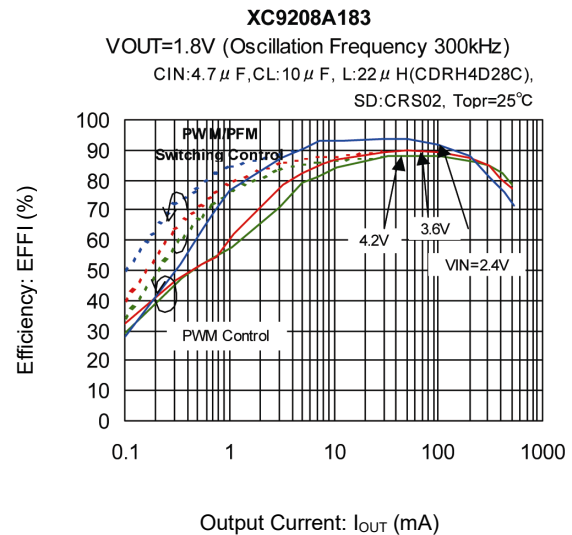
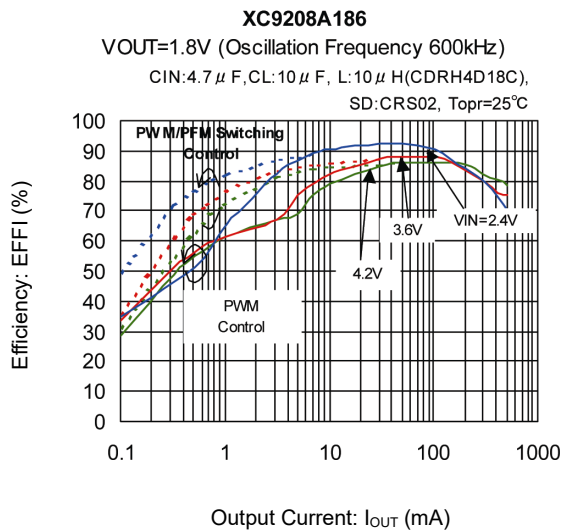
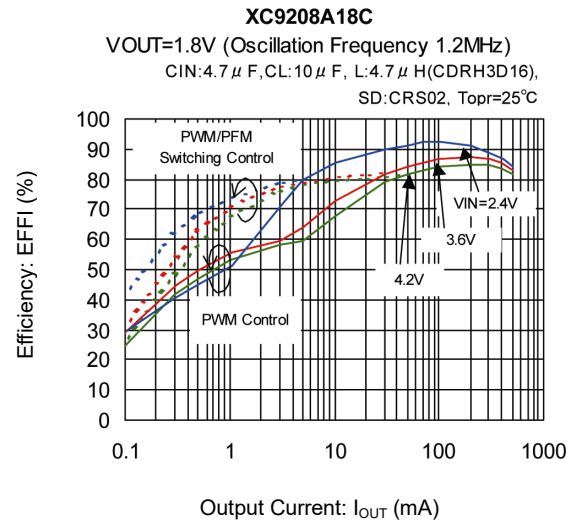
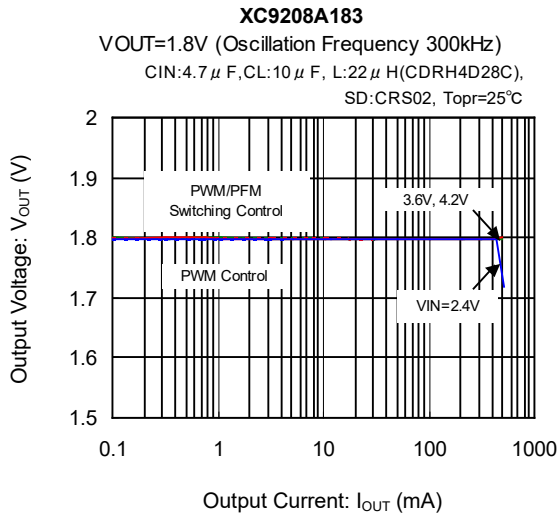

## TYPICAL PERFORMANCE CHARACTERISTICS (Continued)

### (3) Ripple Voltage vs. Output Current

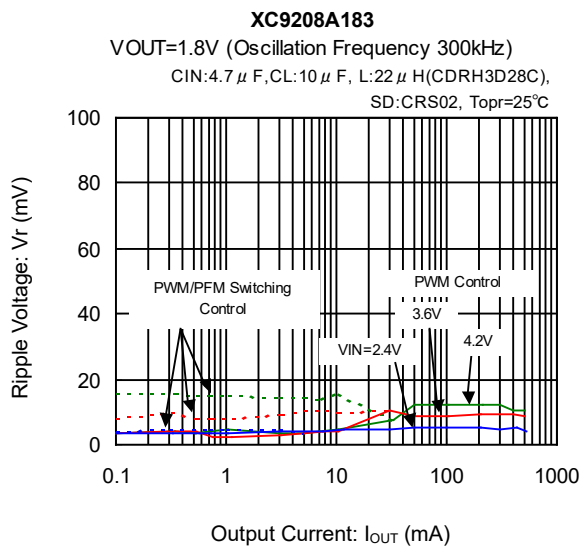
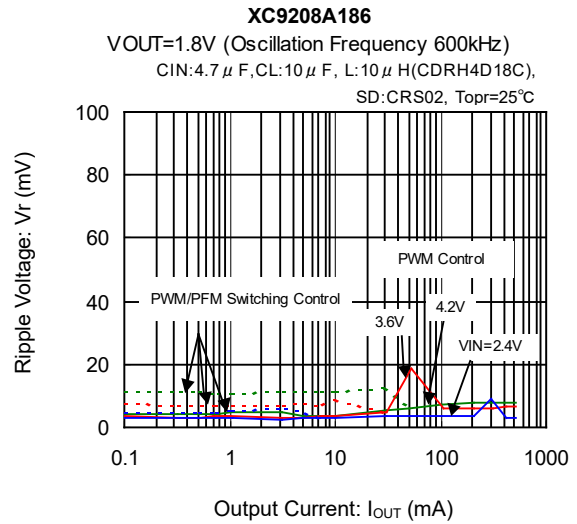
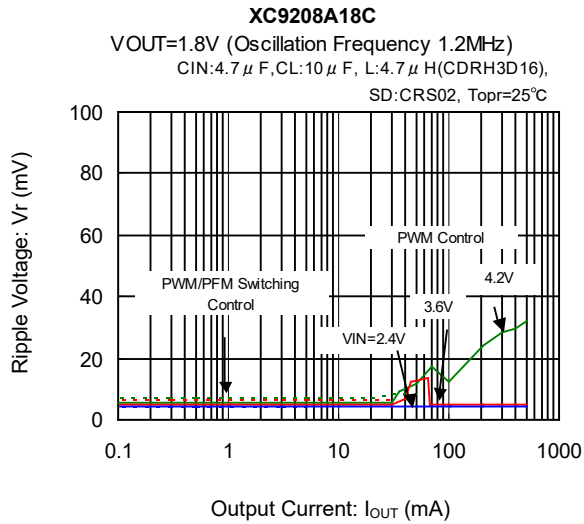

## PACKAGING INFORMATION

### ● SOT-25

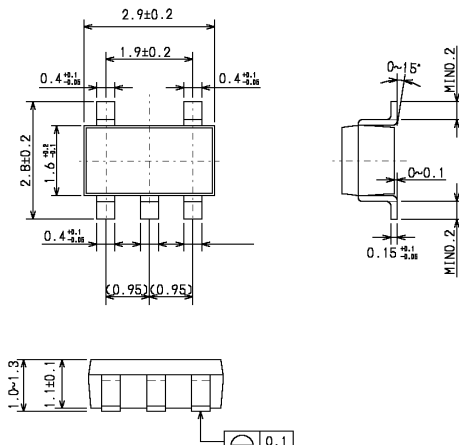

## MARKING RULE

### ● SOT-25

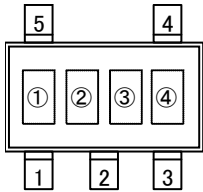

SOT-25  
(TOP VIEW)

① Represents product name and type of DC/DC converters

MARK	PRODUCT SERIES
6	XC9206AxxxMx
7	XC9207AxxxMx
8	XC9208AxxxMx

\* Character inversion is used.

② Represents integer of output voltage and oscillation frequency

MARK			OUTPUT VOLTAGE (V)
FOSC=300kHz	FOSC=600kHz	FOSC=1.2MHz	
XC920xx②x3Mx	XC920xx②x6Mx	XC920xx②xCMx	
0	0	A	0.x
1	1	B	1.x
2	2	C	2.x
3	3	D	3.x
4	4	E	4.x

③ Represents decimal number of output voltage and oscillation frequency

MARK			OUTPUT VOLTAGE (V)
FOSC=300kHz	FOSC=600kHz	FOSC=1.2MHz	
XC920xxx③3Mx	XC920xxx③6Mx	XC920xxx③CMx	
0	A	A	x. 0
1	B	B	x. 1
2	C	C	x. 2
3	D	D	x. 3
4	E	E	x. 4
5	F	F	x. 5
6	H	H	x. 6
7	K	K	x. 7
8	L	L	x. 8
Z	Y	Y	x. 85
9	M	M	x. 9

\* Output voltage 0.9V ~ 4.0V (100mV increments), 1.85V and 2.85V are standard products.  
Output voltages other than these are available as semi-custom products.

②③ example :

OSCILLATION FREQUENCY	MARK					
	VOUT=3.3V		VOUT=5.0V		VOUT=1.85V	
	②	③	②	③	②	③
300kHz	3	3	5	0	1	Z
600kHz	3	D	5	A	1	Y
1.2MHz	D	D	F	A	B	Y

④ Represents production lot number  
0 to 9, A to Z repeated (G, I, J, O, Q, W excepted)

1. The products and product specifications contained herein are subject to change without notice to improve performance characteristics. Consult us, or our representatives before use, to confirm that the information in this catalog is up to date.
2. We assume no responsibility for any infringement of patents, patent rights, or other rights arising from the use of any information and circuitry in this catalog.
3. Please ensure suitable shipping controls (including fail-safe designs and aging protection) are in force for equipment employing products listed in this catalog.
4. The products in this catalog are not developed, designed, or approved for use with such equipment whose failure of malfunction can be reasonably expected to directly endanger the life of, or cause significant injury to, the user.  
(e.g. Atomic energy; aerospace; transport; combustion and associated safety equipment thereof.)
5. Please use the products listed in this catalog within the specified ranges.  
Should you wish to use the products under conditions exceeding the specifications, please consult us or our representatives.
6. We assume no responsibility for damage or loss due to abnormal use.
7. All rights reserved. No part of this catalog may be copied or reproduced without the prior permission of Torex Semiconductor Ltd.

**TOREX SEMICONDUCTOR LTD.**