

## Zener Diode

### FEATURES

**Environmentally Friendly** : EU RoHS Compliant, Pb Free

### APPLICATIONS

● Voltage Regulation

### PRODUCT NAME

PRODUCT NAME	PACKAGE	ORDER UNIT
XBZ02P1201-G *	SOD-523P	5,000/Reel

\* The "-G" suffix denotes Halogen and Antimony free as well as being fully EU RoHS compliant

### MARKING

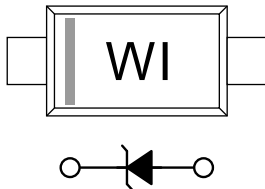

### PACKAGING INFORMATION

● SOD-523P

Unit : inch (mm)

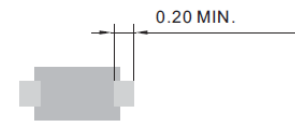
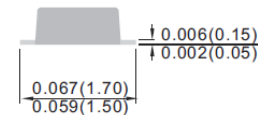
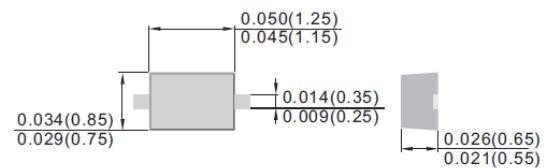

### ABSOLUTE MAXIMUM RATINGS

Ta=25°C

PARAMETER	SYMBOL	RATINGS	UNIT
Power Dissipation	Pd	200 <sup>(*)</sup>	mW
Junction Temperature	Tj	150	°C
Storage Temperature	Tstg	-55 to +150	°C

(\*) PCB mounted

### ELECTRICAL CHARACTERISTICS

Ta=25°C

PARAMETER	SYMBOL	TEST CONDITIONS	LIMITS			UNIT
			MIN.	TYP.	MAX.	
Zener Voltage	V <sub>Z</sub>	I <sub>ZT</sub> =5mA	11.4	12	12.6	V
Zener Impedance	Z <sub>ZT1</sub>	I <sub>ZT</sub> =5mA	-	-	25	Ω
	Z <sub>ZT2</sub>	I <sub>ZT</sub> =1mA	-	-	150	Ω
Reverse Current	I <sub>R</sub>	V <sub>R</sub> =8.0V	-	-	0.1	μA

## TYPICAL PERFORMANCE CHARACTERISTICS

(1) Zener Current vs. Zener Voltage

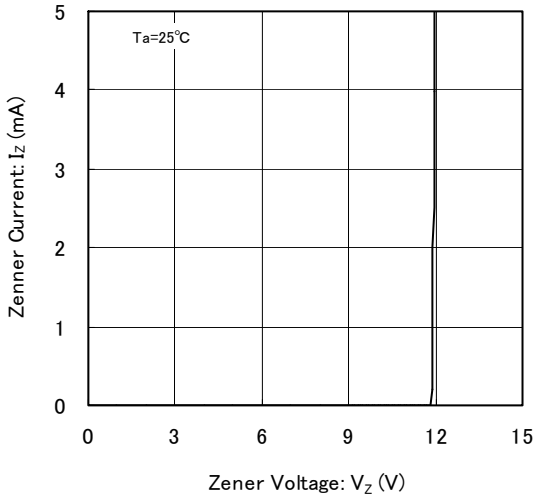

(2) Forward Current vs. Forward Voltage

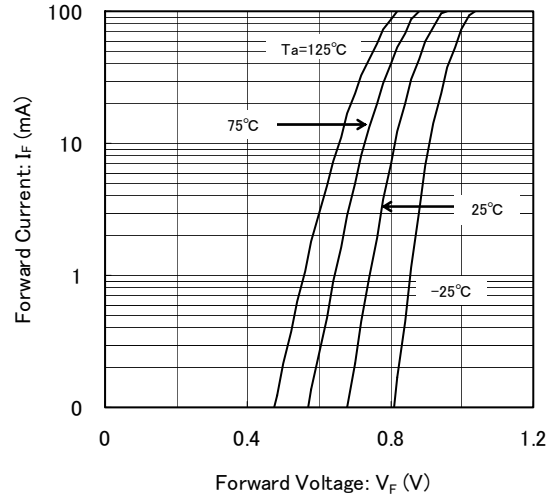

(3) Terminal Capacitance vs. Reverse Voltage

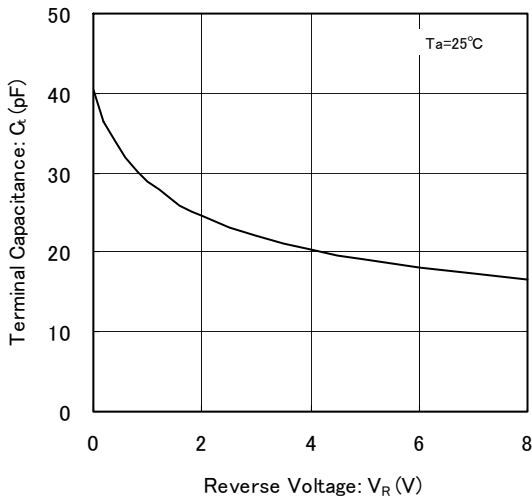

(4) Power Dissipation vs. Operating Temperature

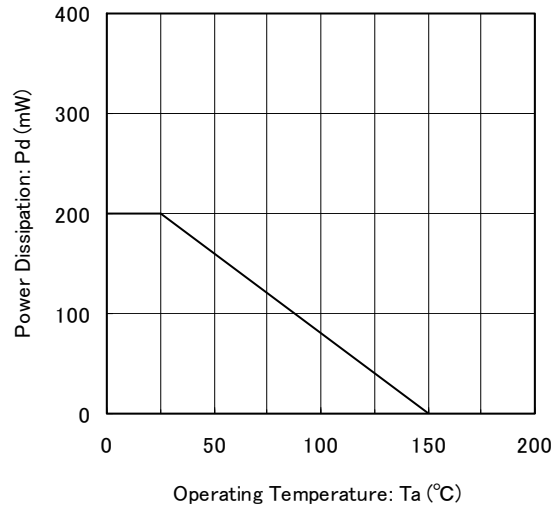

## NOTES ON USE

1. Please use this IC within the absolute maximum ratings.

Even within the ratings, in case of high load use continuously such as high temperature, high voltage, high current and thermal stress may cause reliability degradation of the IC.

2. Torex places an importance on improving our products and their reliability.

We request that users incorporate fail-safe designs and post-aging protection treatment when using Torex products in their systems.

## REFERENCE PATTERN LAYOUT

●SOD-523P

Unit : inch (mm)

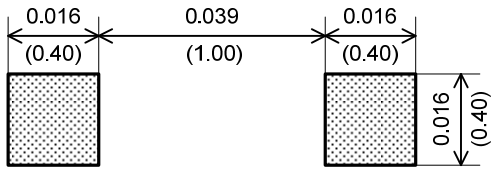

# XBZ02P1201-G

## TAPING SPECIFICATIONS

●SOD-523P

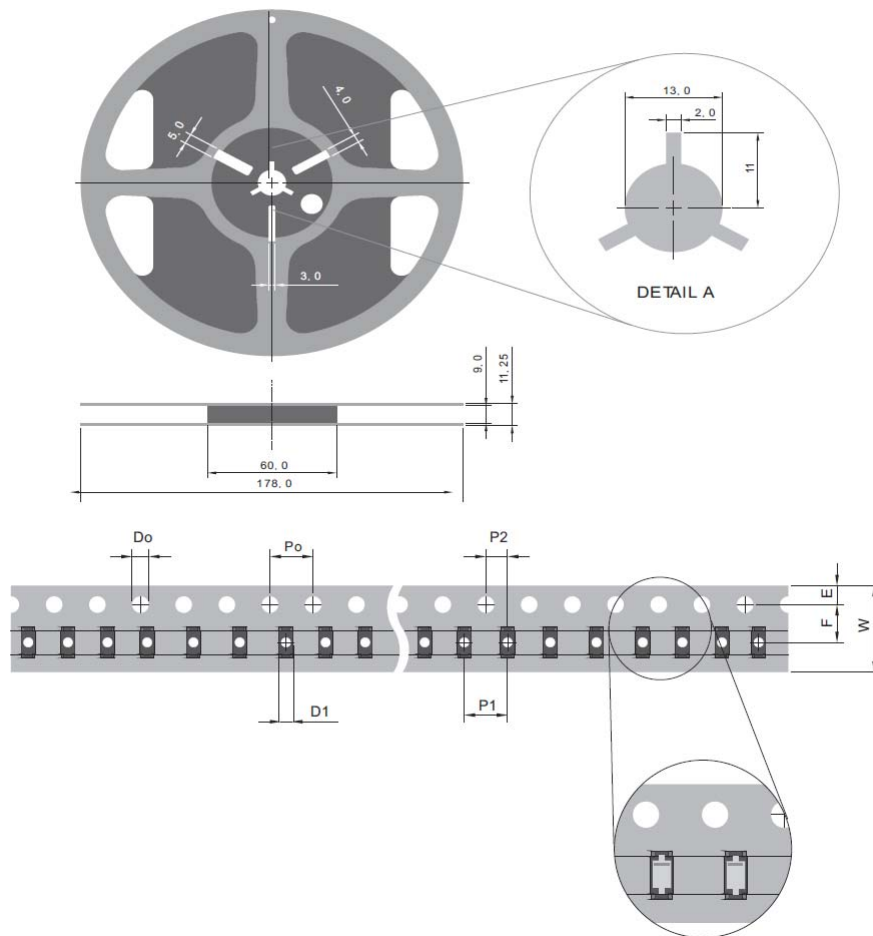

SYMBOL	mm
D <sub>0</sub>	1.50 ± 0.10
D <sub>1</sub>	0.50 ± 0.25
E	1.75 ± 0.10
F	3.50 ± 0.05
P <sub>0</sub>	4.00 ± 0.10
P <sub>1</sub>	4.00 ± 0.10
P <sub>2</sub>	2.00 ± 0.05
W	8.00 + 0.3 - 0.15

1. The products and product specifications contained herein are subject to change without notice to improve performance characteristics. Consult us, or our representatives before use, to confirm that the information in this datasheet is up to date.
2. We assume no responsibility for any infringement of patents, patent rights, or other rights arising from the use of any information and circuitry in this datasheet.
3. Please ensure suitable shipping controls (including fail-safe designs and aging protection) are in force for equipment employing products listed in this datasheet.
4. The products in this datasheet are not developed, designed, or approved for use with such equipment whose failure or malfunction can be reasonably expected to directly endanger the life of, or cause significant injury to, the user.  
(e.g. Atomic energy; aerospace; transport; combustion and associated safety equipment thereof.)
5. Please use the products listed in this datasheet within the specified ranges.  
Should you wish to use the products under conditions exceeding the specifications, please consult us or our representatives.
6. We assume no responsibility for damage or loss due to abnormal use.
7. All rights reserved. No part of this datasheet may be copied or reproduced without the prior permission of TOREX SEMICONDUCTOR LTD.

**TOREX SEMICONDUCTOR LTD.**